

FICHE D'HOMOLOGATION HOMOLOGATION FORM

256/CA/08



COMMISSION INTERNATIONALE DE KARTING – FIA



PROTECTION ARRIERE / REAR PROTECTION



Constructeur	<i>Manufacturer</i>	CRG
Marque	<i>Make</i>	CRG
Modèle	<i>Model</i>	New Age
Catégorie	<i>Category</i>	Toutes / All
Durée de l'homologation	<i>Validity of the homologation</i>	3 ans / years
Nombre de pages	<i>Number of pages</i>	4

La présente Fiche d'Homologation reproduit descriptions, illustrations et dimensions au moment de l'homologation CIK-FIA.

This Homologation Form reproduces descriptions, illustrations and dimensions at the moment of the CIK-FIA homologation.

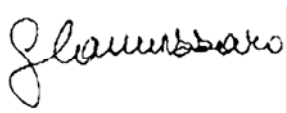

PHOTO VUE DE DESSUS DE LA PROTECTION ARRIERE AVEC SES SUPPORTS
PHOTO FROM ABOVE OF REAR PROTECTION WITH ITS SUPPORTS

Signature et tampon de l'ASN <i>Signature and stamp of the ASN</i>	Signature et tampon de la CIK-FIA <i>Signature and stamp of the CIK-FIA</i>
 	 

PROTECTION ARRIERE - CARROSSERIE
Dessin technique (dimensions d'encombrement)

REAR PROTECTION - BODYWORK
Technical drawing (main external dimensions)

Poids en g (carrosserie seule)

*Weight in g (bodywork only)***1850 g**

+/-10 %

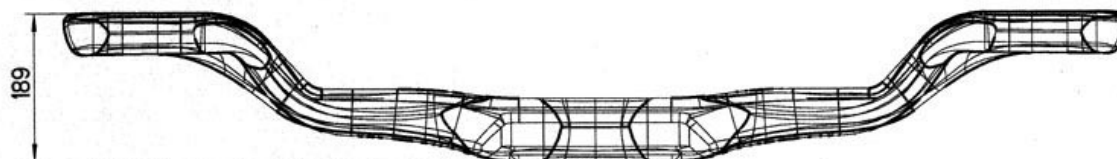
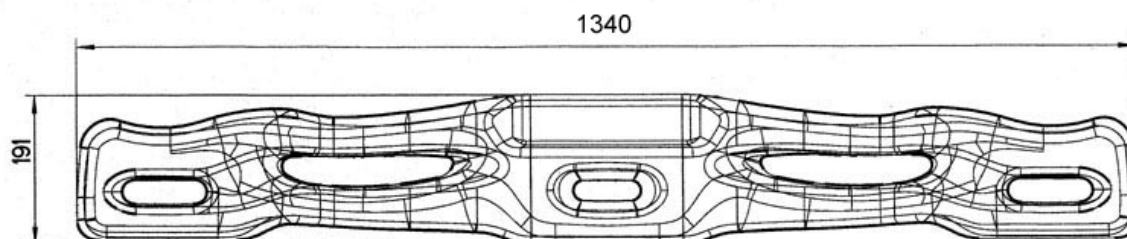

PHOTO (carrosserie seule) / (bodywork only)



SUPPORTS DE FIXATION
Dessin technique éclaté**ATTACHMENT SUPPORTS**
Exploded technical drawing

Poids en g

Weight in g

1250 g

+/-5 %

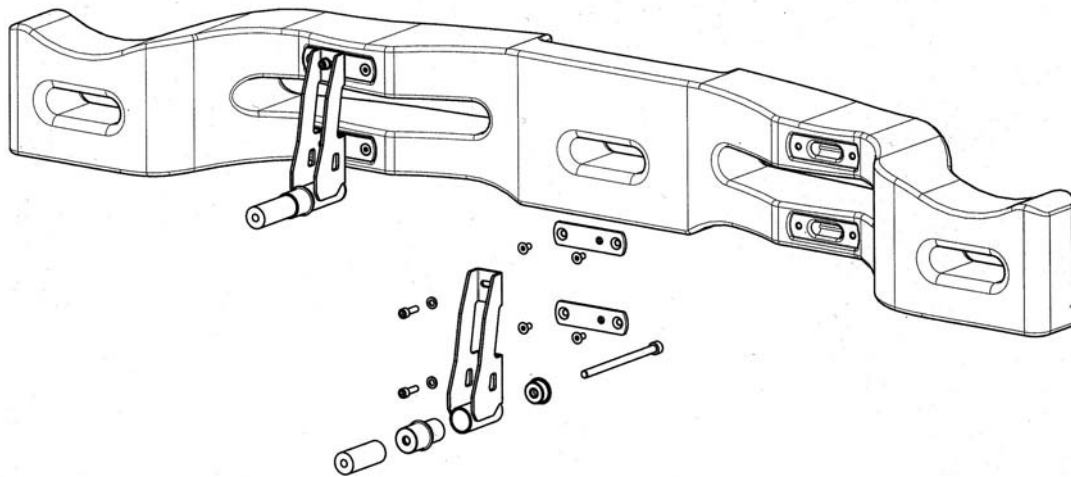

PHOTO DU MARQUAGE DU NUMERO D'HOMOLOGATION
PHOTO OF THE HOMOLOGATION NUMBER MARKING

CARROSSERIE

BODYWORK



SUPPORTS

